

COOPERATE WITH YOU

HEART TOGETHER
WIN THE FUTURE

HOSON TOOL

FOSHAN HOSONTOOL DEVELOPMENT HARDWARE CO.,LTD

FOSHAN HOSONTOOL DEVELOPMENT HARDWARE CO.,LTD

 Add: Datong Baishan Industrial Park, Xiqiao Town, Nanhai District
Foshan City, Guangdong Province, China

 Tel: +86-757-86510663

 Sales website: <https://hosontool.en.alibaba.com/>

 E-mail: info@hosontool.com

About Hosontool

Foshan Hosontool Development Hardware Co., Ltd., is located in Foshan City, Guangdong Province, the famous city of furniture manufacturing. We specialize in various types of furniture staples & nails and pneumatic tools, focusing on product quality while providing high-quality one-stop sales services to achieve a win-win situation with our customers.

With a professional production and sales team, our customers cover various countries around the world, especially in Southeast Asia, North America, and South America.

“Heart together, win the future” , we genuinely hope to cooperate with you.

CONTENTS

✦ 02 Staples	✦ 07 Brad & Finish Nails	✦ 08 Concrete & Pin Nails	✦ 09 Coil Nails
✦ 10 Coil Nailers	✦ 11 Framing Nails & Staples	✦ 13 Carton Staples Corrugate Nails	✦ 14 Gas Nails High carbon steel Staples

10F Series

(22GA 10F Series Staples)

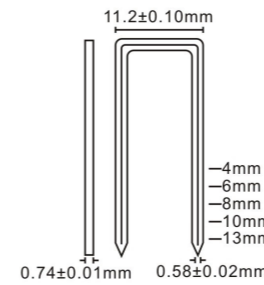
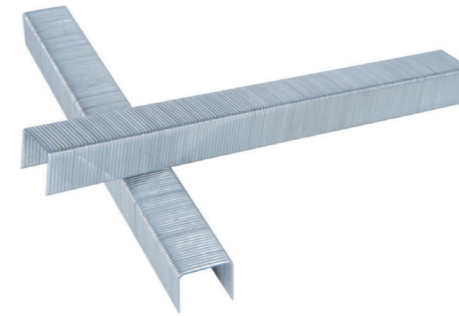

1013F Stapler (22GA, 7/16" Crown Stapler)

- Dimensions: 145*220*47mm
- Capacity: 100pcs
- Fastener Length: 5mm-13mm
- Weight: 0.88kg



71 Series

(22GA 71 Series Staples)

7116 Stapler (22GA, 3/8" Crown Stapler)

- Dimensions: 147*227*47mm
- Capacity: 160pcs
- Fastener Length: 4mm-16mm
- Weight: 0.90kg

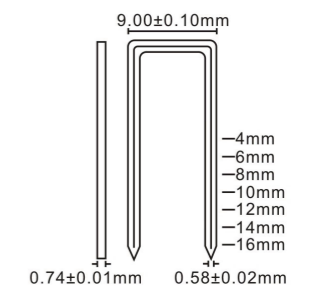
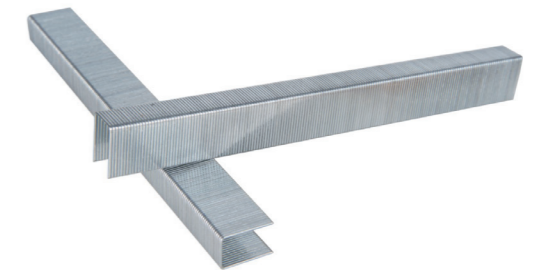

14 Series

(22GA 14 Series Staples)

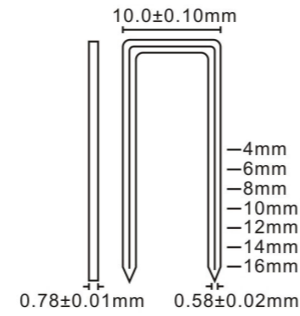
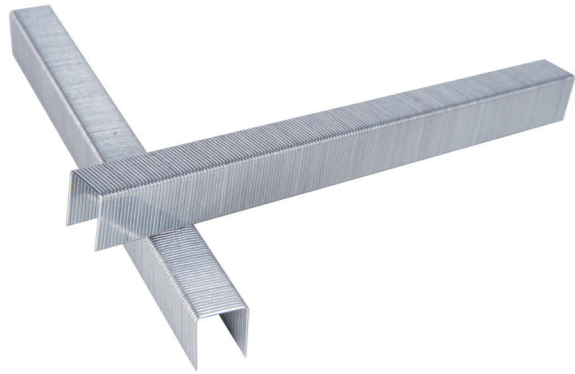

80 Series

(21GA 80 Series Staples)

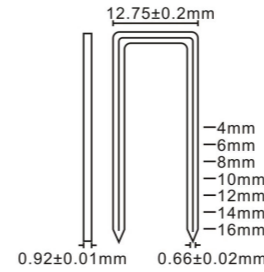
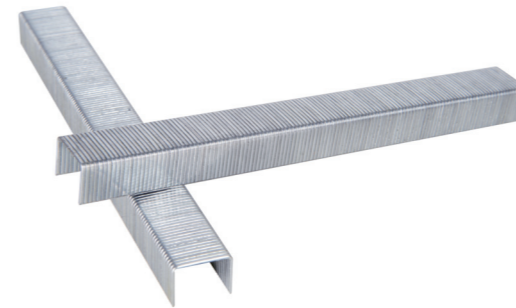

8016 Stapler (21GA, 1/2" Crown Stapler)

- Dimensions: 147*227*47mm
- Capacity: 140pcs
- Fastener Length: 4mm-16mm
- Weight: 0.90kg



13/1008F Series

(22GA 13/1008F Series Staples)

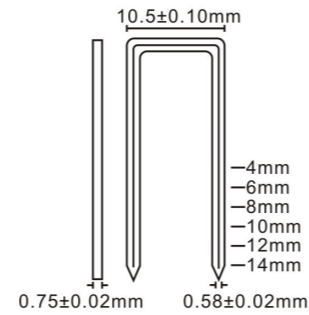
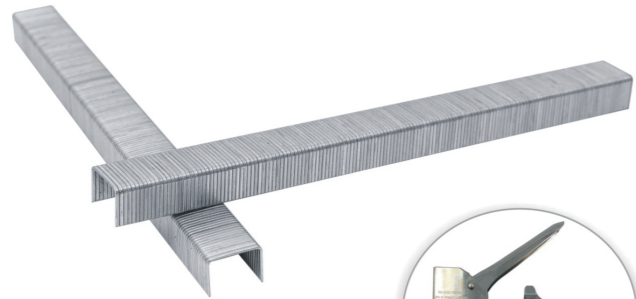

1013J Stapler (20GA, 7/16" Crown Stapler)

- Dimensions: 145*220*47mm
- Capacity: 100pcs
- Fastener Length: 5mm-13mm
- Weight: 0.88kg

10J Series

(20GA 10J Series Staples)



84 Series

(21GA 84 Series Staples)

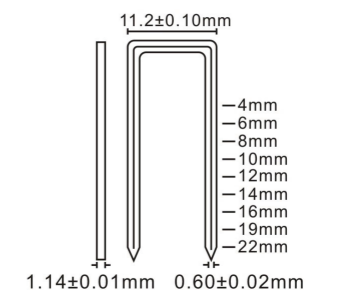
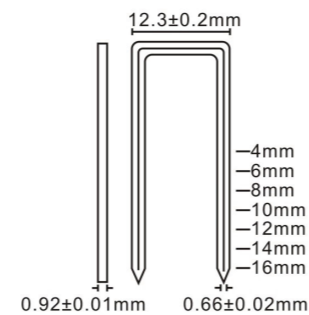
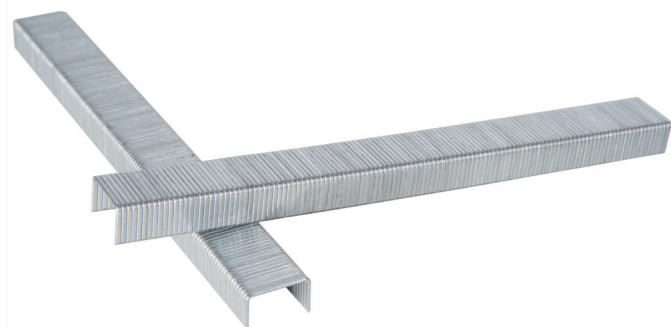





4J Series

(20GA 4J Series Staples)



422J Stapler (20GA, 0.20" Crown Stapler)

-  Dimensions: 179*250*59mm
-  Capacity: 100pcs
-  Fastener Length: 4mm-22mm
-  Weight: 1.20kg

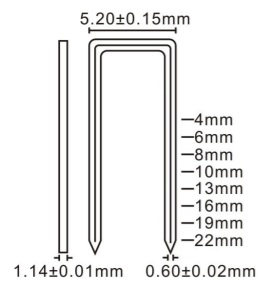





92 Series

(18GA 92 Series Staples)



9240 Stapler (18GA, 0.34" Medium Crown Stapler)

-  Dimensions: 372*262*78mm
-  Capacity: 200pcs
-  Fastener Length: 20mm-40mm
-  Weight: 1.94kg

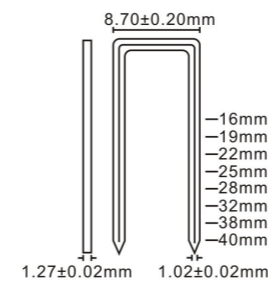

90 Series

(18GA 90 Series Staples)



JS440K (9040) Stapler (18GA, Medium Crown Stapler)

-  Dimensions: 308*242*75mm
-  Capacity: 160pcs
-  Fastener Length: 13mm-40mm
-  Weight: 2.10kg

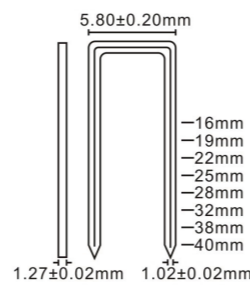





N/55/100 Series

(16GA N Series Staples)



N851 Stapler (16GA, 7/16" Medium Crown Stapler)

-  Dimensions: 389*300*97mm
-  Capacity: 160pcs
-  Fastener Length: 25mm-50mm
-  Weight: 2.50kg

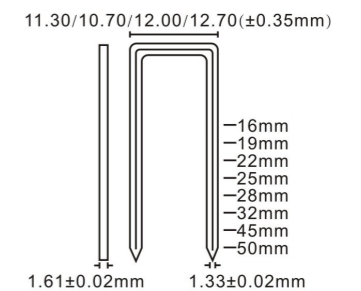

F Series

(18GA F Series Brad Nails)

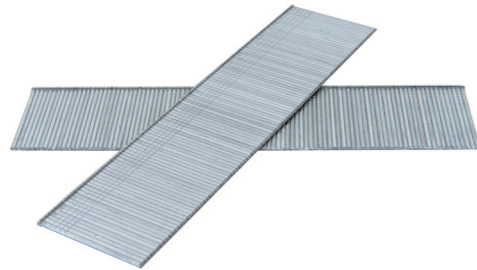

F50 Brad Nailer (18GA, 2" Brad Nailer)

- Dimensions: 244*44*59mm
- Capacity: 100pcs
- Fastener Length: 15mm-50mm
- Weight: 1.35kg

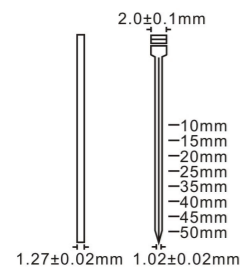

ST Series

(14GA ST Series Concrete Nails)

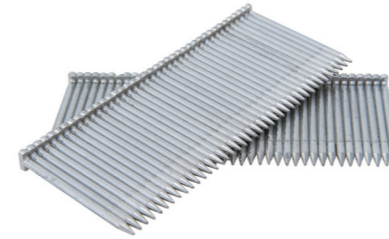

ST64 Concrete Nailer (14GA, 64mm Concrete Nailer)

- Dimensions: 310*316*101mm
- Capacity: 80pcs
- Fastener Length: 18mm-64mm
- Weight: 2.47kg



T Series

(16GA T Series Finish Nails)

T50 Finish Nailer (16GA, 2" Finish Nailer)

- Dimensions: 286*268*75.5mm
- Capacity: 100pcs
- Fastener Length: 20mm-50mm
- Weight: 1.72kg

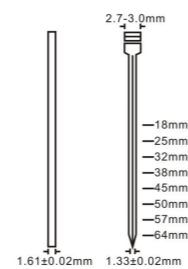
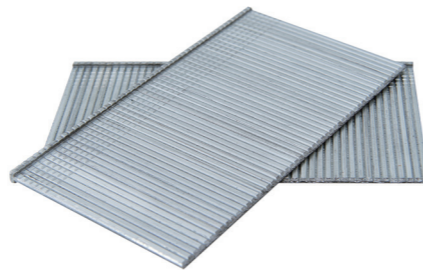

630 Pin Nailer (23GA, 1-3/16" Micro Pinner)

- Dimensions: 188*267*47mm
- Capacity: 200pcs
- Fastener Length: 15mm-30mm
- Weight: 1.04kg

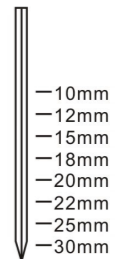
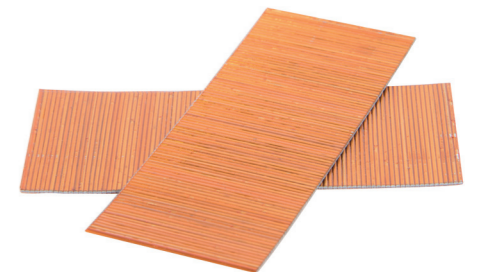

Coil Nails

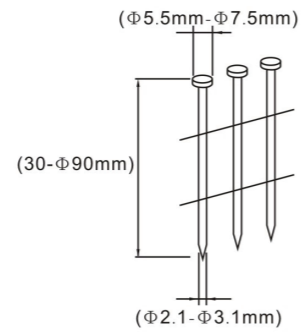
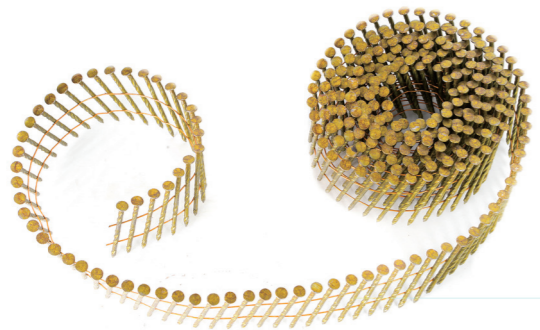

Series	Length	Pcs/Ctn	Shank Dia
2.1mm	2.1*30	30±1.5	2.1±0.10
	2.1*32	32±1.5	
	2.1*35	35±1.5	
	2.1*38	38±1.5	
	2.1*40	40±1.5	
	2.1*45	45±1.5	
2.3mm	2.3*38	38±1.5	2.3±0.10
	2.3*45	45±1.5	
	2.3*50	50±1.5	
	2.3*55	55±1.5	
	2.3*57	57±1.5	
	2.3*64	64±1.5	
2.5mm	2.5*45	45±1.5	2.5±0.10
	2.5*50	50±1.5	
	2.5*55	55±70	
	2.5*60	60±70	
	2.5*65	65±70	
	2.5*70	70±1.5	
2.8mm	2.8*50	50±1.5	2.8±0.10
	2.8*55	55±1.5	
	2.8*57	57±1.5	
	2.8*60	60±1.5	
	2.8*65	65±1.5	
	2.5*75	75±1.5	
3.1mm	3.1*75	75±1.5	3.1±0.10
	3.1*83	83±1.5	
	3.1*90	90±1.5	

CN55

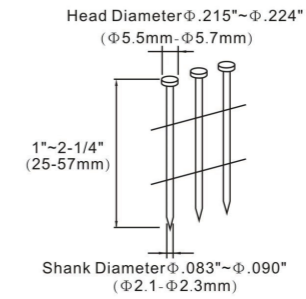

(15 Degree Industrial Coil Nailer)

- Dimensions: 269*273*135mm
- Fastener Length: 25mm-57mm
- Capacity: 1 roll (300-400pcs)
- Weight: 2.63kg

CN70

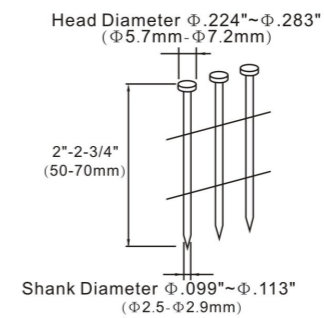

(15 Degree Industrial Coil Nailer)

- Dimensions: 317*306*135mm
- Fastener Length: 50mm-70mm
- Capacity: 1 roll (250-300pcs)
- Weight: 3.48kg

CN80

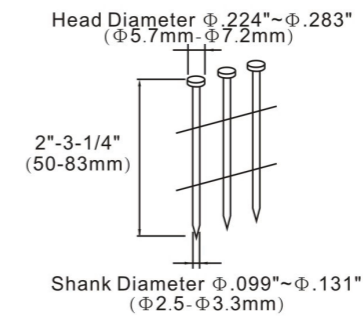

(15 Degree Industrial Coil Nailer)

- Dimensions: 353*306*137mm
- Fastener Length: 50mm-83mm
- Capacity: 1 roll (250-300pcs)
- Weight: 3.7kg

CN100

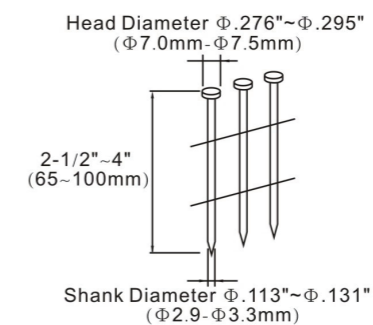

(15 Degree Industrial Coil Nailer)

- Dimensions: 405*378*153mm
- Fastener Length: 65mm-100mm
- Capacity: 1 roll (200-250pcs)
- Weight: 5.6kg

Framing Nails

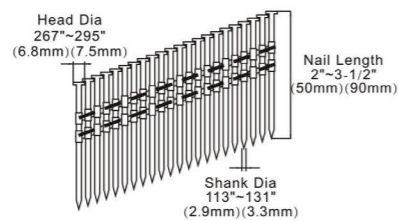
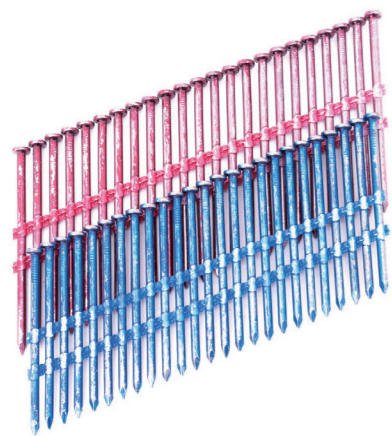

Collation
21 Degree
Plastic collated
Fullround head nails



2190 Framing Nailer

- Dimensions:339*500*114mm
- Capacity:64pcs
- Fastener Length:50mm-90mm
- Weight:3.6kg

P Series

(16GA P Series Staples)



P Staplers

- Dimensions:262*362*76mm
- Capacity:110pcs
- Fastener Length:16mm-38mm
- Weight::2.28kg

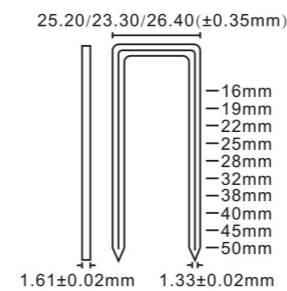

Framing Nails

- Diameter: 2.8mm, 3.0mm, 3.3mm
- Collation:34 °
- Length:50mm,60mm,65mm
70mm,75mm, 83mm, 90mm
- Collation Type: Paper
- Material:Q235

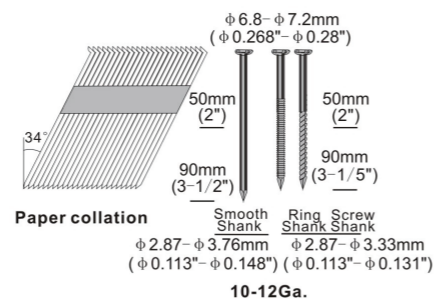

DA Series Nails

- Width:1.61mm ± 0.02mm
- Thickness:1.33mm ± 0.02mm
- Diameter: 1.76 ± 0.01mm
- Length:32mm,38mm, 45mm, 50mm, 64mm
- Material:Steel
- Color:Sliver(yellow coating)

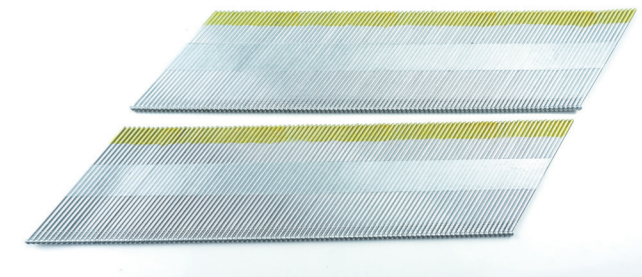

Carton Staples Series



ADCS-22 Carton Stapler

- Dimensions: 342*115*220mm
- Capacity: 100pcs
- Fastener Length: 18mm
- Weight: 2.15kg

35 Series
(16GA 35 Series Staples)

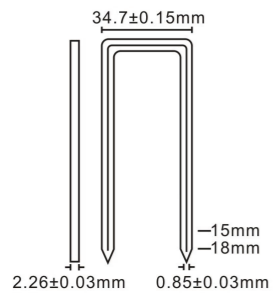

32 Series
(16GA 32 Series Staples)

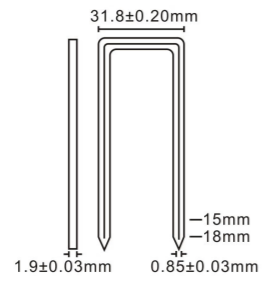

Concrete Nails



CS26 38 Concrete Nailer

- Dimensions: 349*464*117mm
- Capacity: 42pcs
- Fastener Length: 12mm-38mm
- Weight: 3.69kg

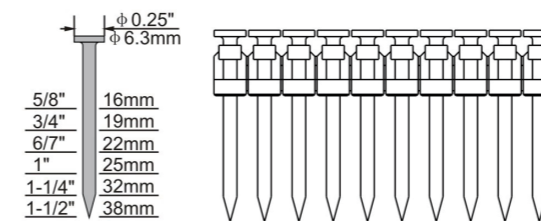

Corrugate Nails

WS2513 Corrugate Stapler

- Dimensions: 350*92*275mm
- Capacity: 100pcs
- Fastener Length: 6.5mm-12.7mm
- Weight: 3.37kg

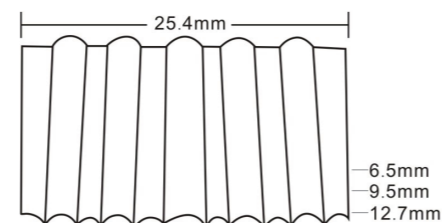
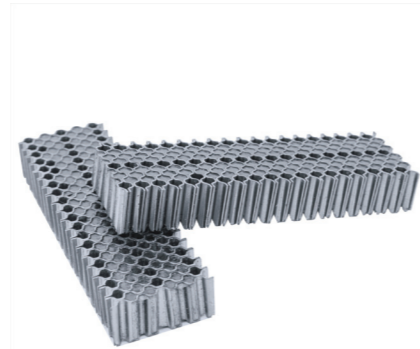

High carbon steel 4K Staples

- Crown: 5.7 ± 0.2mm
- Width: 1.25mm ± 0.02mm
- Color: Black
- Thickness: 1.05mm ± 0.02mm
- Length: 10mm, 13mm, 16mm, 19mm
- Diameter: 1.19mm
- Material: High carbon steel, SS304

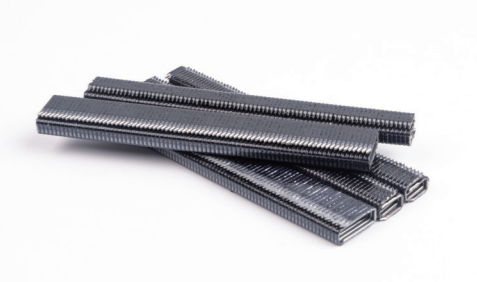

BCS15 Staples

(15.5 GA 1/2" Staples)

- Crown: 1/2" (12.7mm)
- Width: 1.61mm ± 0.02mm
- Thickness: 1.33mm ± 0.02mm
- Diameter: 1.50mm
- Length: 38mm, 45mm, 50mm
- Material: Steel

